

# MSIW2000 Series

3W, Wide Input Range SMD, Single & Dual Output DC/DC Converters



## Key Features



- Efficiency up to 83%
- 1500VDC Isolation
- MTBF > 1,000,000 Hours
- 4:1 Wide Input Range
- Short Circuit Protection
- Temperature Performance -40°C to +71°C
- Industry Standard Pinout
- UL 94V-0 Package Material
- Internal SMD Construction
- Complies with EN55022 Class A



Component Distributors, Inc. ~ www.cdiweb.com

~ sales@cdiweb.com ~ 1-800-777-7334

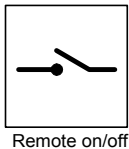

Remote on/off



EN55022

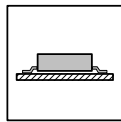

SMD

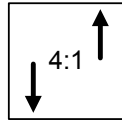

Wide Range

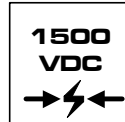

I/O Isolation

Minmax's MSIW2000 3W DC/DC's are in "gull-wing" SMT package. The series consists of 14 models that operate over input voltage ranges of 9–36VDC and 18–75VDC which provide precisely regulated output voltages of 3.3V, 5V, 12V, 15V, ±5V, ±12V and ±15VDC.

The -40°C to +71°C operating temperature range makes it ideal for data communication equipments, mobile battery driven equipments, distributed power systems, telecommunication equipments, mixed analog/digital subsystems, process/machine control equipments, computer peripheral systems and industrial robot systems.

The modules have a maximum power rating of 3W and a typical full-load efficiency of 83%, continuous short circuit, built-in filtering for both input and output minimize the need for external filtering.

The MSIW2000 units are available in tape and reel package.

## Absolute Maximum Ratings

Parameter	Min.	Max.	Unit
Input Surge Voltage (1000 mS)	24VDC Input Models	-0.7	50 VDC
	48VDC Input Models	-0.7	100 VDC
Lead Temperature (1.5mm from case for 10 Sec.)	---	260	°C
Internal Power Dissipation	---	2,500	mW

Exceeding the absolute maximum ratings of the unit could cause damage. These are not continuous operating ratings.

## Environmental Specifications

Parameter	Conditions	Min.	Max.	Unit
Operating Temperature	Ambient	-40	+71	°C
Operating Temperature	Case	-40	+90	°C
Storage Temperature		-40	125	°C
Humidity		---	95	%
Cooling	Free-Air Convection			
Conducted EMI	EN55022 Class A			

Leadfree Reflow Solder Process as per IPC/JEDEC J-STD-020C peak temp. 245C/10 sec.

## Model Selection Guide

Model Number	Input Voltage	Output Voltage	Output Current		Input Current		Reflected Ripple Current	Efficiency
			Max.	Min.	@Max. Load	@No Load		@Max. Load
	VDC	VDC	mA	mA	mA (Typ.)	mA (Typ.)	mA (Typ.)	% (Typ.)
MSIW2021	24 (9 ~ 36)	3.3	750	75	138	20	10	75
MSIW2022		5	600	60	158			79
MSIW2023		12	250	25	154			81
MSIW2024		15	200	20	154			81
MSIW2025		±5	±300	±30	160			78
MSIW2026		±12	±125	±12.5	154			81
MSIW2027		±15	±100	±10	154			81
MSIW2031	48 (18 ~ 75)	3.3	750	75	68	10	5	76
MSIW2032		5	600	60	78			80
MSIW2033		12	250	25	75			83
MSIW2034		15	200	20	75			83
MSIW2035		±5	±300	±30	78			80
MSIW2036		±12	±125	±12.5	75			83
MSIW2037		±15	±100	±10	75			83

## Capacitive Load

Models by Vout	3.3V	5V	12V	15V	±5V #	±12V #	±15V #	Unit
Maximum Capacitive Load	3000	3000	3000	3000	180	180	180	uF

# For each output

## Input Fuse Selection Guide

24V Input Models	48V Input Models
1000mA Slow – Blow Type	500mA Slow – Blow Type

## Input Specifications

Parameter	Model	Min.	Typ.	Max.	Unit
Start Voltage	24V Input Models	4.5	6	8.5	VDC
	48V Input Models	8.5	12	17	
Under Voltage Shutdown	24V Input Models	---	---	8	
	48V Input Models	---	---	16	
Reverse Polarity Input Current	All Models	---	---	1	A
Short Circuit Input Power		---	---	2000	mW
Input Filter		Pi Filter			

## Output Specifications

Parameter	Conditions	Min.	Typ.	Max.	Unit
Output Voltage Accuracy		---	±0.5	±1.0	%
Output Voltage Balance	Dual Output, Balanced Loads	---	±0.5	±2.0	%
Line Regulation	Vin=Min. to Max.	---	±0.2	±0.5	%
Load Regulation	Io=10% to 100%	---	±0.3	±1.0	%
Ripple & Noise (20MHz)		---	50	75	mV P-P
Ripple & Noise (20MHz)	Over Line, Load & Temp.	---	---	100	mV P-P
Ripple & Noise (20MHz)		---	---	15	mV rms
Over Power Protection		120	---	---	%
Transient Recovery Time	25% Load Step Change	---	150	500	µS
Transient Response Deviation		---	±2	±6	%
Temperature Coefficient		---	±0.01	±0.02	%/°C
Output Short Circuit	Continuous				

## General Specifications

Parameter	Conditions	Min.	Typ.	Max.	Unit
Isolation Voltage Rated	60 Seconds	1500	---	---	VDC
Isolation Voltage Test	Flash Tested for 1 Second	1650	---	---	VDC
Isolation Resistance	500VDC	1000	---	---	MΩ
Isolation Capacitance	100KHz, 1V	---	350	500	pF
Switching Frequency		---	300	---	KHz
MTBF	MIL-HDBK-217F @ 25°C, Ground Benign	1000	---	---	K Hours

## Remote On/Off Control

Parameter	Conditions	Min.	Typ.	Max.	Unit
Supply On	2.5 to 5.5 VDC or Open Circuit				
Supply off		-0.7	---	0.8	VDC
Device Standby Input Current		---	---	5	mA
Control Input Current ( on )	Vin=Min. to Max.	---	---	-400	µA
Control Input Current ( off )	Vin=Min. to Max.	---	---	-400	µA
Control Common	Referenced to Negative Input				

### Notes :

1. Specifications typical at Ta=+25°C, resistive load, nominal input voltage, rated output current unless otherwise noted.
2. Transient recovery time is measured to within 1% error band for a step change in output load of 75% to 100%.
3. Ripple & Noise measurement bandwidth is 0-20 MHz.
4. These power converters require a minimum output loading to maintain specified regulation.
5. Operation under no-load conditions will not damage these modules; however, they may not meet all specifications listed.
6. All DC/DC converters should be externally fused at the front end for protection.
7. Other input and output voltage may be available, please contact factory.
8. Specifications subject to change without notice.
9. It is not recommended to use water-washing process on SMT units.

## Block Diagram

### Single Output

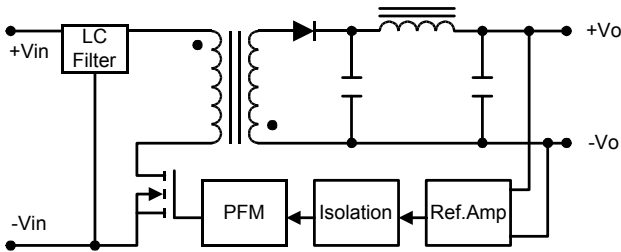

### Dual Output

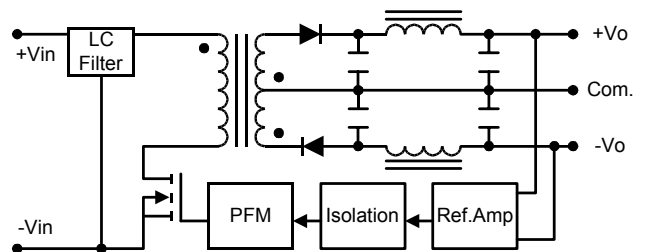

Component Distributors, Inc. ~ [www.cdiweb.com](http://www.cdiweb.com) ~ [sales@cdiweb.com](mailto:sales@cdiweb.com) ~ 1-800-777-7334

## Input Voltage Transient Rating

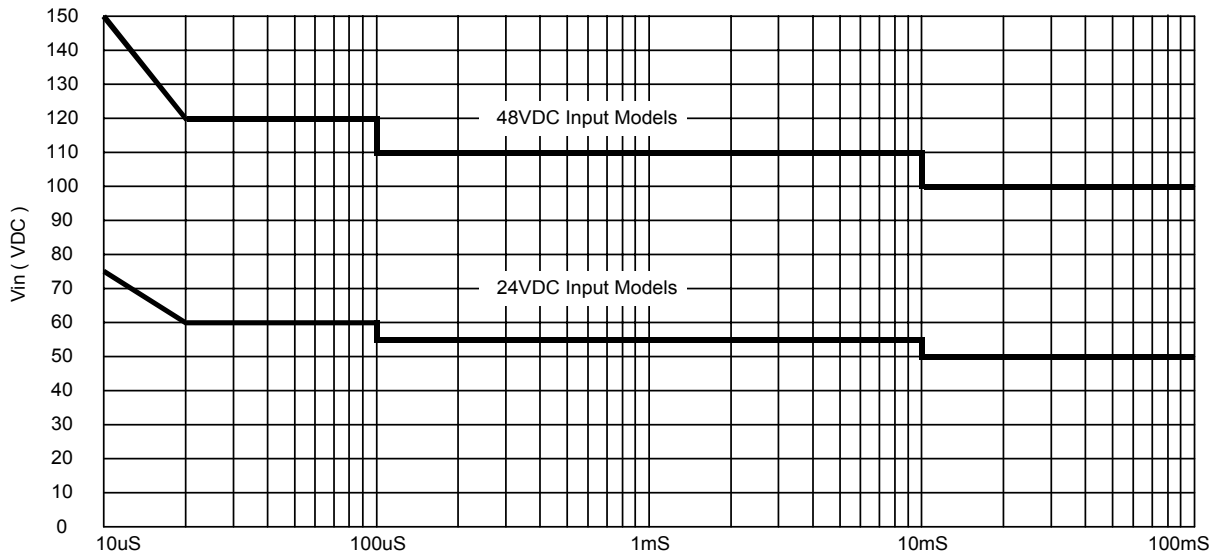

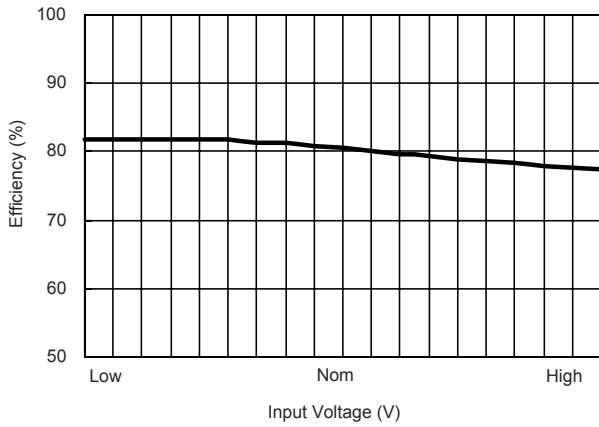

**Efficiency vs Input Voltage ( Single Output )**

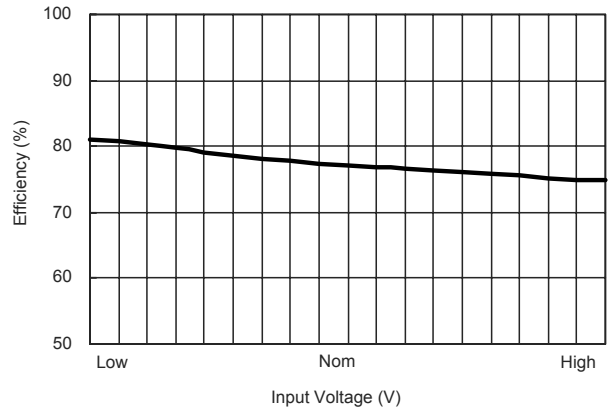

**Efficiency vs Input Voltage ( Dual Output )**

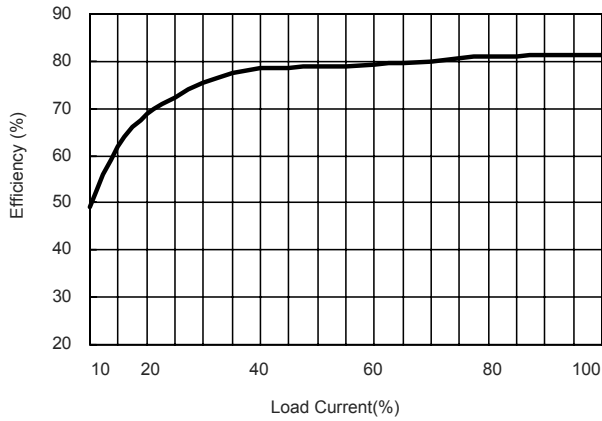

**Efficiency vs Output Load ( Single Output )**

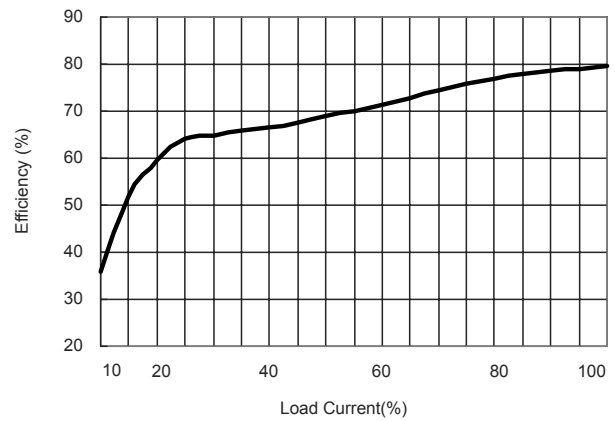

**Efficiency vs Output Load ( Dual Output )**

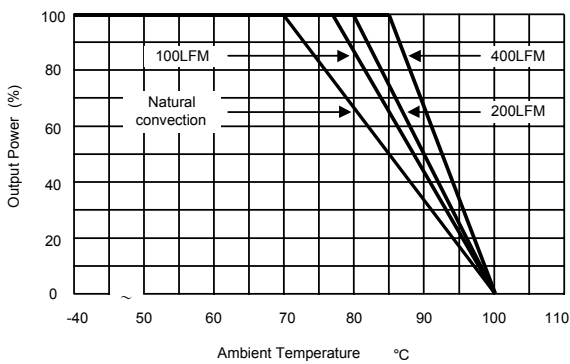

**Derating Curve**

## Test Configurations

### Input Reflected-Ripple Current Test Setup

Input reflected-ripple current is measured with an inductor  $L_{in}$  (4.7uH) and  $C_{in}$  (220uF, ESR < 1.0Ω at 100 KHz) to simulate source impedance.

Capacitor  $C_{in}$ , offsets possible battery impedance.

Current ripple is measured at the input terminals of the module, measurement bandwidth is 0–500 KHz.

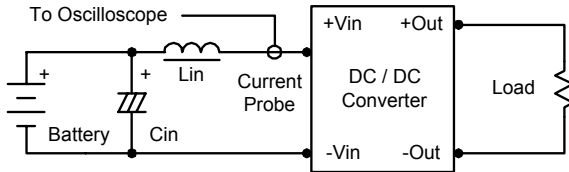

### Peak-to-Peak Output Noise Measurement Test

Use a  $C_{out}$  0.47uF ceramic capacitor.

Scope measurement should be made by using a BNC socket, measurement bandwidth is 0–20 MHz. Position the load between 50 mm and 75 mm from the DC/DC Converter.

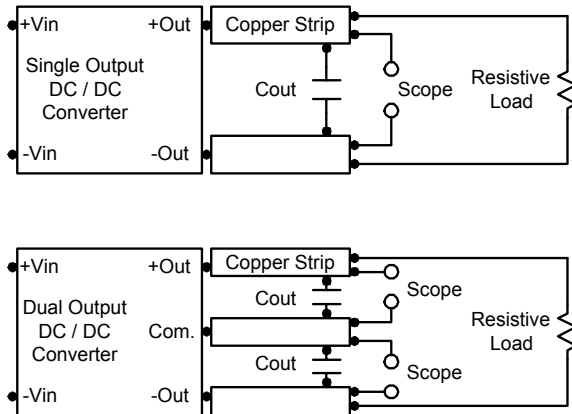

## Design & Feature Considerations

### Remote On/Off

Positive logic remote on/off turns the module on during a logic high voltage on the remote on/off pin, and off during a logic low.

To turn the power module on and off, the user must supply a switch to control the voltage between the on/off terminal and the  $-V_{in}$  terminal.

The switch can be an open collector or equivalent.

A logic low is  $-0.7V$  to  $0.8V$ .

A logic high is  $2.5V$  to  $5.5V$ .

The maximum sink current of the switch at on/off terminal during a logic low is  $-300 \mu A$ .

The maximum sink current of the switch at on/off terminal during a logic high is  $-200 \mu A$  or open.

### Maximum Capacitive Load

The MSIW2000 series has limitation of maximum connected capacitance at the output.

The power module may be operated in current limiting mode during start-up, affecting the ramp-up and the startup time.

For optimum performance we recommend 180uF maximum capacitive load for dual outputs and 3000uF capacitive load for single outputs.

The maximum capacitance can be found in the data sheet.

### Overcurrent Protection

To provide protection in a fault (output overload) condition, the unit is equipped with internal current limiting circuitry and can endure current limiting for an unlimited duration. At the point of current-limit inception, the unit shifts from voltage control to current control. The unit operates normally once the output current is brought back into its specified range.

### Input Source Impedance

The power module should be connected to a low ac-impedance input source. Highly inductive source impedances can affect the stability of the power module.

In applications where power is supplied over long lines and output loading is high, it may be necessary to use a capacitor at the input to ensure startup.

Capacitor mounted close to the power module helps ensure stability of the unit, it is recommended to use a good quality low Equivalent Series Resistance (ESR < 1.0Ω at 100 KHz) capacitor of a 4.7uF for the 24V input devices and a 2.2uF for the 48V devices.

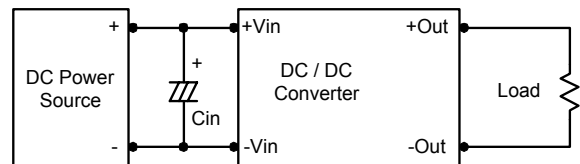

## Output Ripple Reduction

A good quality low ESR capacitor placed as close as practicable across the load will give the best ripple and noise performance.

To reduce output ripple, it is recommended to use 3.3uF capacitors at the output.

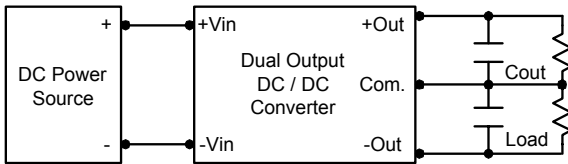
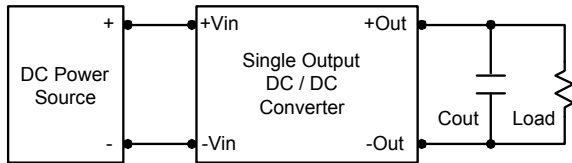

## Thermal Considerations

Many conditions affect the thermal performance of the power module, such as orientation, airflow over the module and board spacing. To avoid exceeding the maximum temperature rating of the components inside the power module, the case temperature must be kept below 90°C.

The derating curves are determined from measurements obtained in an experimental apparatus.

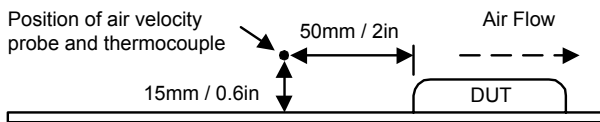

## Mechanical Dimensions

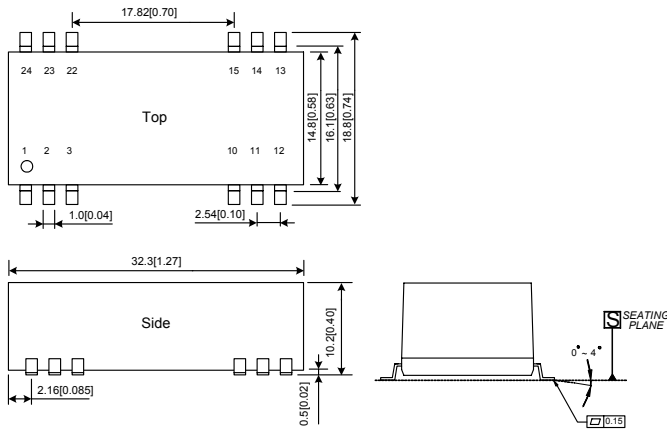

## Connecting Pin Patterns

Top View ( 2.54 mm / 0.1 inch grids )

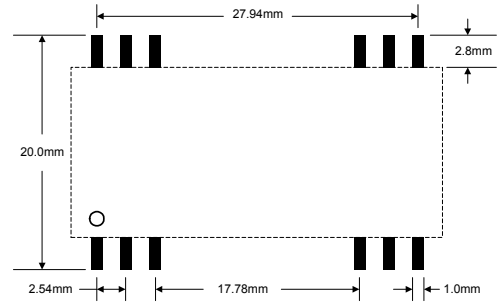

Tolerance	Millimeters	Inches
	$X.X \pm 0.25$	$X.XX \pm 0.01$
	$X.XX \pm 0.13$	$X.XXX \pm 0.005$
Pin	$\pm 0.05$	$\pm 0.002$

## Pin Connections

Pin	Single Output	Dual Output
1	-Vin	-Vin
2	-Vin	-Vin
3	Remote On/Off	Remote On/Off
10	NC	Common
11	NC	NC
12	NC	-Vout
13	+Vout	+Vout
14	NC	NC
15	-Vout	Common
22	NC	NC
23	+Vin	+Vin
24	+Vin	+Vin

NC: No Connection

## Physical Characteristics

Case Size	:	32.3x14.8x10.2 mm 1.27x0.58x0.40 inches
Case Material	:	Non-Conductive Black Plastic
Weight	:	8.8g
Flammability	:	UL94V-0