

world leaders in the art of linear measurement

wigauge™

New Wireless Bore Gauge (WBG)

- 10mm & 6mm Diameter fixing threads (as used on most popular Gauge Heads)
- Up to 0.1µm resolution (user selectable)
- Up to 15 Metre Data transmission, via Class 1 *Bluetooth®*
- Up to 7 WBG connected to a single system
- 10 hours battery life (based on continuous data transmission)
- Fast battery recharge
- IP 65 protection
- Pass/Fail range lamps
- Audio indication of data transmission



The freedom to roam with Solartron's new **wigauge** brings increased efficiency to gauging stations and work practices. The ability to work without the obstacles that cables put onto conventional electronic gauges means that the gauging process is not restricted by cable length and routing, or the risk of cable damage.

The audio and visual Pass/Fail indicators on the **wigauge** give the operator the opportunity to decide whether or not to remove a component from a machine tool while the reading is logged into a system that can be up to 15 metres away. The rugged construction and class 1 *Bluetooth®* communication ensure that it is able to work reliably in the often hostile environment of an engineering machine shop.

Post process gauging stations become more flexible and with the ability to connect up to 7 WBG's to a single receiver, cable tangles are eliminated in multi point gauging applications.

Technical Specification

Measurement Performance	
Internal Transducer Mechanical Travel	11mm
Internal Transducer Measurement Range	10mm
Internal Transducer Pre travel	0.15mm
Internal Transducer –Accuracy	0.1µm + 0.1%D (Where D= displacement in mm)
Internal Transducer Tip Force	1.2N ± 20% @ mid-position
Hand tool Accuracy	Dependent on gauge head fitted
Hand Tool repeatability	Dependent on gauge head fitted
Resolution	Down to 0.1µm (user selectable)
Bluetooth Performance	
Reading Rate	Streaming Mode: 67 readings per second maximum. (Can be set to lower data rates by controller)
Range	The hand tool is a Class 1 <i>Bluetooth</i> ® device which has a range of 100m. However in a normal industrial environment a range of 15m is most likely.
Battery Life	
Supplied battery pack	10 hours based on continuous data transmission Using supplied rechargeable battery pack.
Functionality	
Auto Power Down	Auto power down can be set to either OFF or from 1 to 600 seconds.
Zero	The reading can be zeroed by a command from the controller.
User Interface	
Controls	Two buttons.
Indications	Buttons illuminate to indicate different criteria, including Pass/Fail range Lamps, Low Battery power and <i>Bluetooth</i> ® status
Environmental	
Sealing	IP65
Operating Temperature	+10°C to +50°C
Storage Temperature	0°C to + 60°C
EMC - Immunity	EN61000-6-2:2001 (Radiated Only)
EMC - Emmissions	EN61000-6-3:2001 (Radiated Only)

Setting up the [wigauge](#) to communicate with a Bluetooth® enabled PC is quick and easy using the drivers supplied on a CD-ROM.

Solartron Metrology recommends using the *Bluetooth*® USB Adapter supplied with the [wigauge](#) pack to obtain the most reliable data communication to the PC.



The **wigaug**e (WBG) is compatible with industry standard 10mm and 6mm gauge head threads. The internal transducer has a 10mm measuring range that enables it to cope with any variations in thread or gauge pin length.

The Transducer is linear along its entire travel while still maintaining 0.1µm resolution, making it easier to set up compared with conventional Analogue gauges.

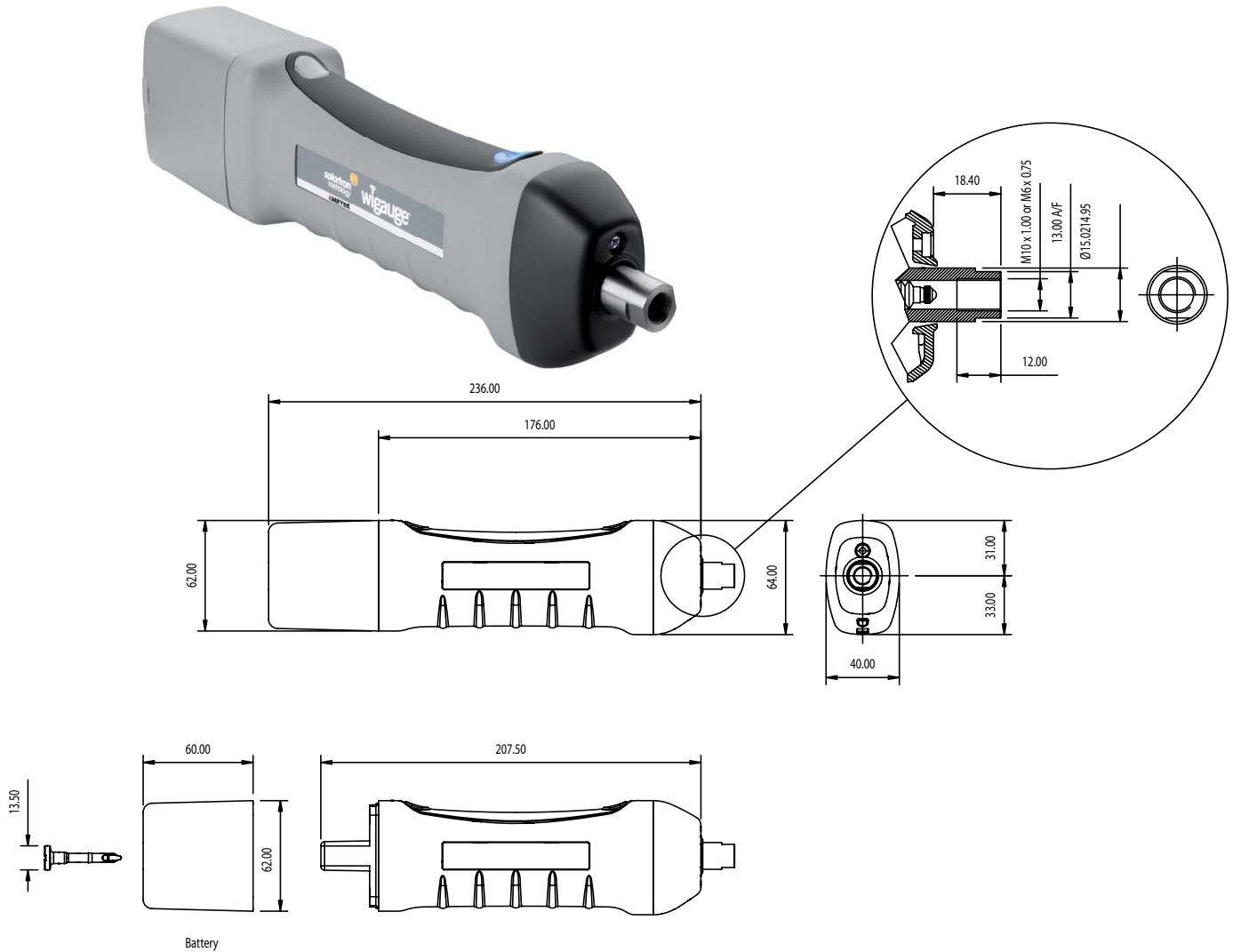

Part Number	Packages
973176K-UK/EU/US	wigaug e (WBG) + 1 x Battery, 1 x Charger with Mains Lead
973177K-UK/EU/US	wigaug e (WBG) + 2 x Battery, 1 x Charger with Mains Lead, 1 x Bluetooth® Adapter, 1 x Manual/CD-ROM
Part Number	Accessories
973167	wigaug e (WBG) Body Only
805811-SX	Class 1 <i>Bluetooth</i> ® USB Adapter
805794-SX	Battery Pack
805812-UK/EU/US	Charger with Mains Lead
009317	Manual

The *Bluetooth*® word mark and logos are registered trademarks owned by *Bluetooth* SIG, Inc and any use of such marks by Solartron Metrology is under license. Other trademarks and trade names are those of their respective owners

Also Available at Solartron Metrology

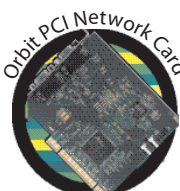
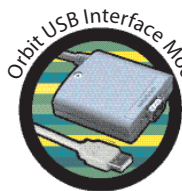
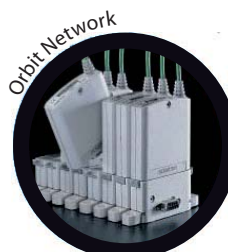
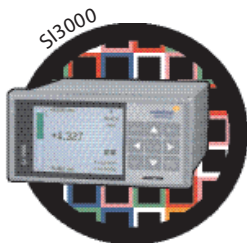
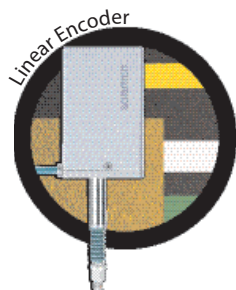
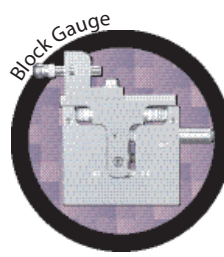
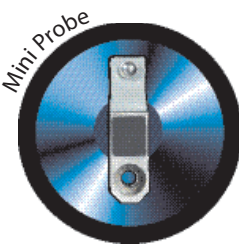
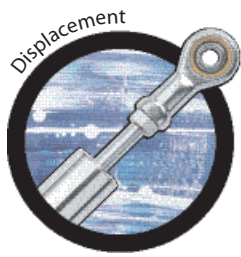
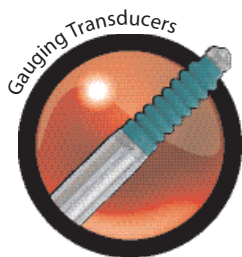

Component Distributors, Inc.

1-800-777-7334

www.cdiweb.com

sales@cdiweb.com