

Height Measuring Instruments Digimar 817 CLM / 816 CL

Accessories

Carrier for probes with mount dia. 6 mm

Catalog no.	Description	Shaft length mm	Order no.
817 h1	Carrier for a probe	27.5	4429154*
817 h2	Carrier for a probe	100	4429219
817 h5	Carrier with a joint for a probe	35	4429454

* Supplied with standard accessories

817 h1

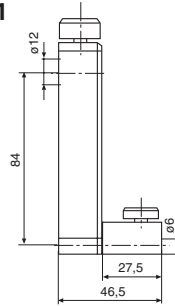

817 h2

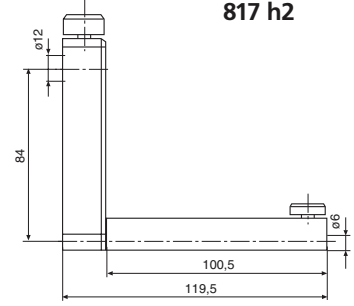

817 h5

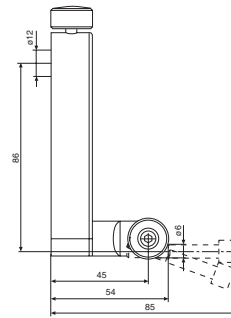

Probes with mount dia. 6 mm

Catalog no.	Description	Order no.
K5/51	Spherical probe	4429158
K6/51	Spherical probe	4429254*
S15/31,2	Disc probe	4429226
Z10/31,2	Cylindrical probe	4429227
MKe 30	Taper probe	4429228
KM 2	Probe M2 incl. styli 800 ts dia. 2 mm	4429256
800 a6	Mounting shaft 800 a6 for MarTest	4301865

* Supplied with standard accessories

K 5/51

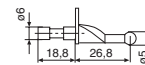

K 6/51

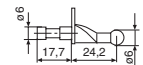

S 15/31,2

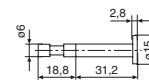

MKe 30

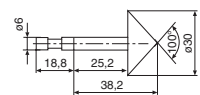

Z 10/31,2

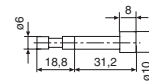

KM 2

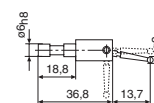

800 a6

